

CAUCHOS INDALO

RECOLECCIÓN DE ALMENDRA Y PISTACHO

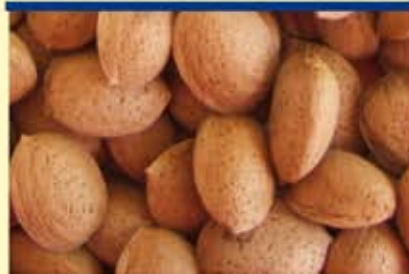

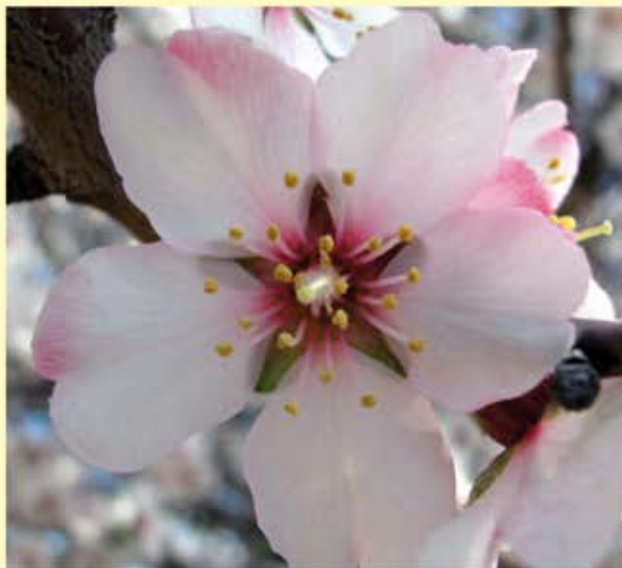

Pág. 156

Partidoras de Almendra.



Pág.157

Mantos de suelo y Mantos con anillas.



Pág. 157

Varas de Fibra de Vidrio y Porras.



Pág. 158

Peladoras de Almendra.



Pág. 159-182

Estrellas para Peladoras.



Pág.174

Recambios para Peladoras.



Pág. 185

Otros varios Juntas Abonadoras Cepillos de limpiar flores.



Pág. 186

Repuestos para Vibradores de tractor.



Pág. 188

Faldillas para Vibradores, Filtro y Goma Caramelo.



Pág. 191

Cilindros y Tacos para Vibradores de tractor.

PARTIDORAS DE ALMENDRA

CÓDIGO	ARTÍCULO	PESO (Kg.)
13100112	Partidora de Frutos Secos Manual	1,95
13100149	Partidora de Almendras 220V.	2,20
13100148	Útil para partir Almendras INOX. - 220V.	10,8



13100112

Partidora de Frutos Secos Manual



CÓDIGO

ARTÍCULO

13100149

Partidora de Almendras doméstica 220V.

CÓDIGO

ARTÍCULO

13100148

Útil para partir Almendras INOX. - 220V.



MANTOS, FARDOS Y VARAS



Mantos de suelo para cosecha

Cosidos en todos sus bordes (Calidad Extra)

CODIGO	DESCRIPCION
13100030	Manto de Recolección 4x6m.
13100072	Manto de Recolección 4x10m.
13100059	Manto de Recolección 5x10m.
13100142	Manto de Recolección 6x10m.
13100051	Manto de Recolección 6x12m.
13100055	Manto de Recolección 7x14m.
13100188	Manto de Recolección 8x12m.

*Podemos fabricar cualquier otra medida sobre pedido

CODIGO	DESCRIPCION
13100143	Mantilla de Recolección Rafia Reforzada con 4 Anillas 2,70x2,70m



Varas Fibra de Vidrio con punteras de fibra

CODIGO	DESCRIPCION
13030006	Varas Fibra de Vidrio 1,85m.
13030045	Varas Fibra de Vidrio 2,10m.
13030473	Varas Fibra de Vidrio 2,50m.
13030474	Varas Fibra de Vidrio 3,00m.



Porras de madera para la recolección de frutos secos

CODIGO	DESCRIPCION
13050018	Cilindro de Porra para Astil de madera L-150x100x36mm. Peso 1kg
14101276	Astil de madera para Porra
13050021	Porra completa Mini C/Mango Duraluminio 60x200 Largo 1m.
13050022	Porra completa C/Mango Duraluminio - Goma 60x200 Largo 1,50m.





PELADORAS DE ALMENDRA Y PISTACHO



Especial para
Almendra Blanda

MODELOS

5000/3

5000/4

5000/10

5000/20



SISTEMA DE LIMPIEZA:
Rodillos en espiral



MODELOS

100/900

200/900

400/900



SISTEMA DE LIMPIEZA:
Parrilla sinfín

CÓDIGO	MODELO	PRODUCCIÓN (Kg/hora) Aprox.	SISTEMA DE PELADO	VELOCIDAD (r.p.m)	ACONDICIONAMIENTO	OBSERVACIONES	PESO (Kg)
13050002	5000/3	300/400	4 Rodillos con espiral (*)	300	Motor Eléctrico Gasolina o Tractor 1,5HP		65
13050003	5000/4	400/500	4 Rodillos con espiral (*)	300	Motor Eléctrico Gasolina o Tractor 2HP		80 110
13050007	5000/10	1000-1500	10 Rodillos con espiral (*)	300	Tracción a cardan Motor Eléctrico o Gasolina	Con ensacador	140 150
	5000/20	2000-2500	20 Rodillos con espiral (*)	300	Tracción a cardan o Motor Eléctrico	Doble cuerpo con ensacador	326 350
13050023	100/900	700-800	Parrilla sinfín	1000	Motor 220V.-3CV		100
13050008	200/900	1000-1500	Parrilla sinfín	1000	Tracción a cardan o Motor Eléctrico	Con embrague y ensacador	130 150
	100/900 Pistacho		Parrilla sinfín	1000	Motor 220V. 3CV Tractor-Cardan		100
	200/900 Pistacho		Parrilla sinfín	1000	Motor 380V. 7,5CV Tractor-Cardan		130 150

(*) El sistema de pelado por rodillos: es muy recomendable para almendras de corteza semiblanda o muy blanda.
 Todos los modelos van montados con el eje central con estrellas de goma fácilmente intercambiables.



RECAMBIOS PARA PELADORAS

ESTUPIÑA

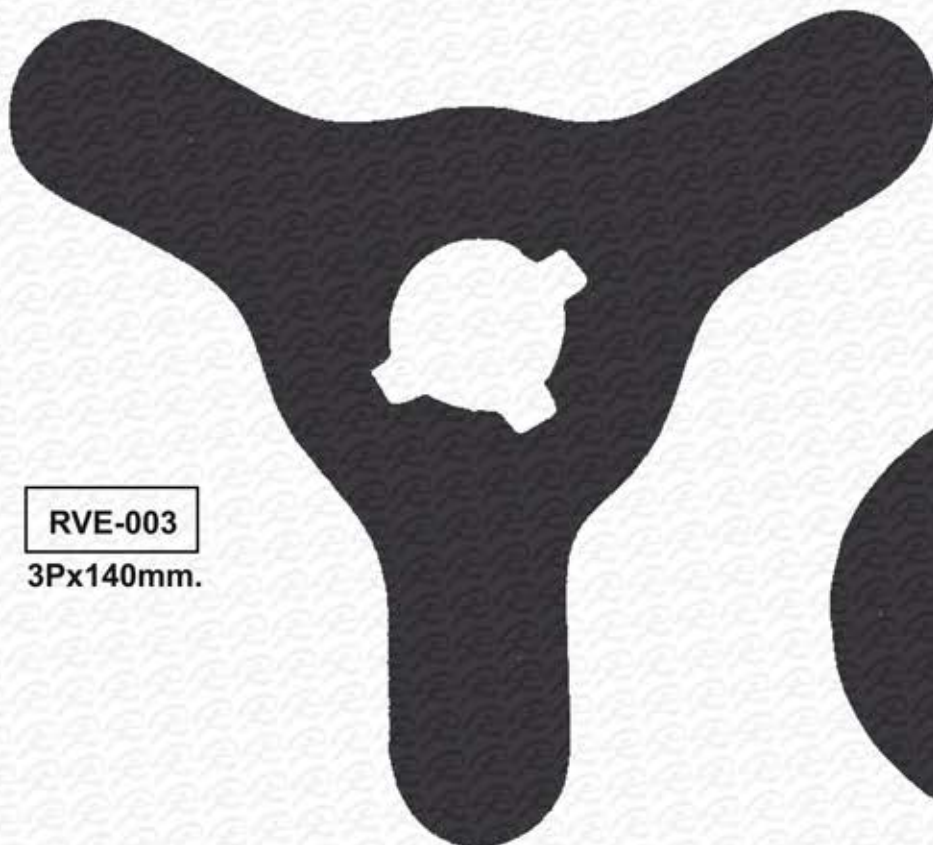

RVE-003

3Px140mm.

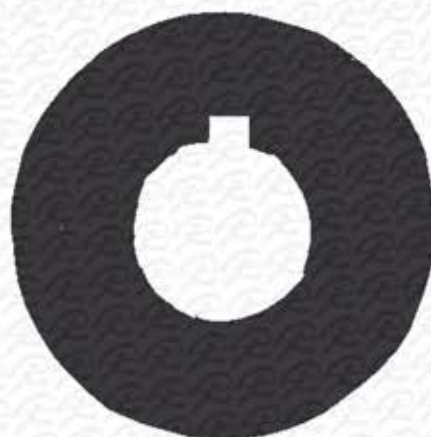

SEPARADOR

RVE-014

Ø58mm.

PARA
LOS MODELOS
5000-1 Y 5000-3

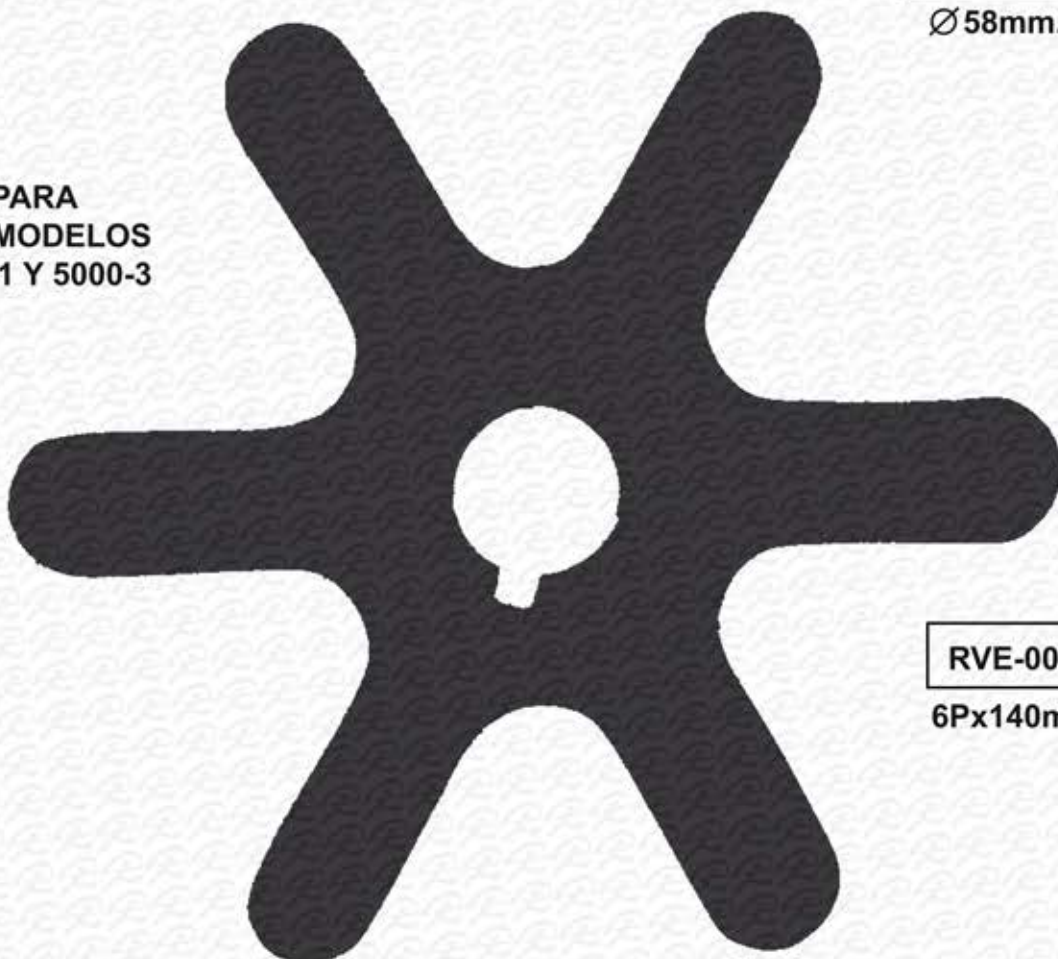

RVE-004

6Px140mm.



ESTUPIÑA

RVE-005

4Px175mm.

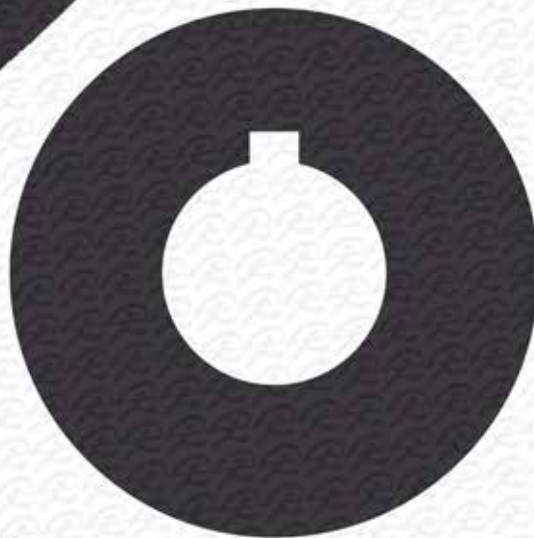

SEPARADOR

RVE-015

Ø 70mm.

PARA
LOS MODELOS
5000-4 Y 5000-6

RVE-007

8Px175mm.



ESTUPIÑA

MUELLE
TENSOR
CADENAS
Peladoras MR

RVE-013



16131410

ENGRANE
CHAVETERO
19Ø



ENGRANE
16Ø

16131387 IZQUIERDO

16131386 DERECHO



16131411

SEPARADOR
DE
POLEA





RVE-027

DESCATALOGADA
6Px135mm

RVE-004

6Px140mm.

RVE-006

DESCATALOGADA

SUSTITUIDA POR

RVE-007

8Px175mm.

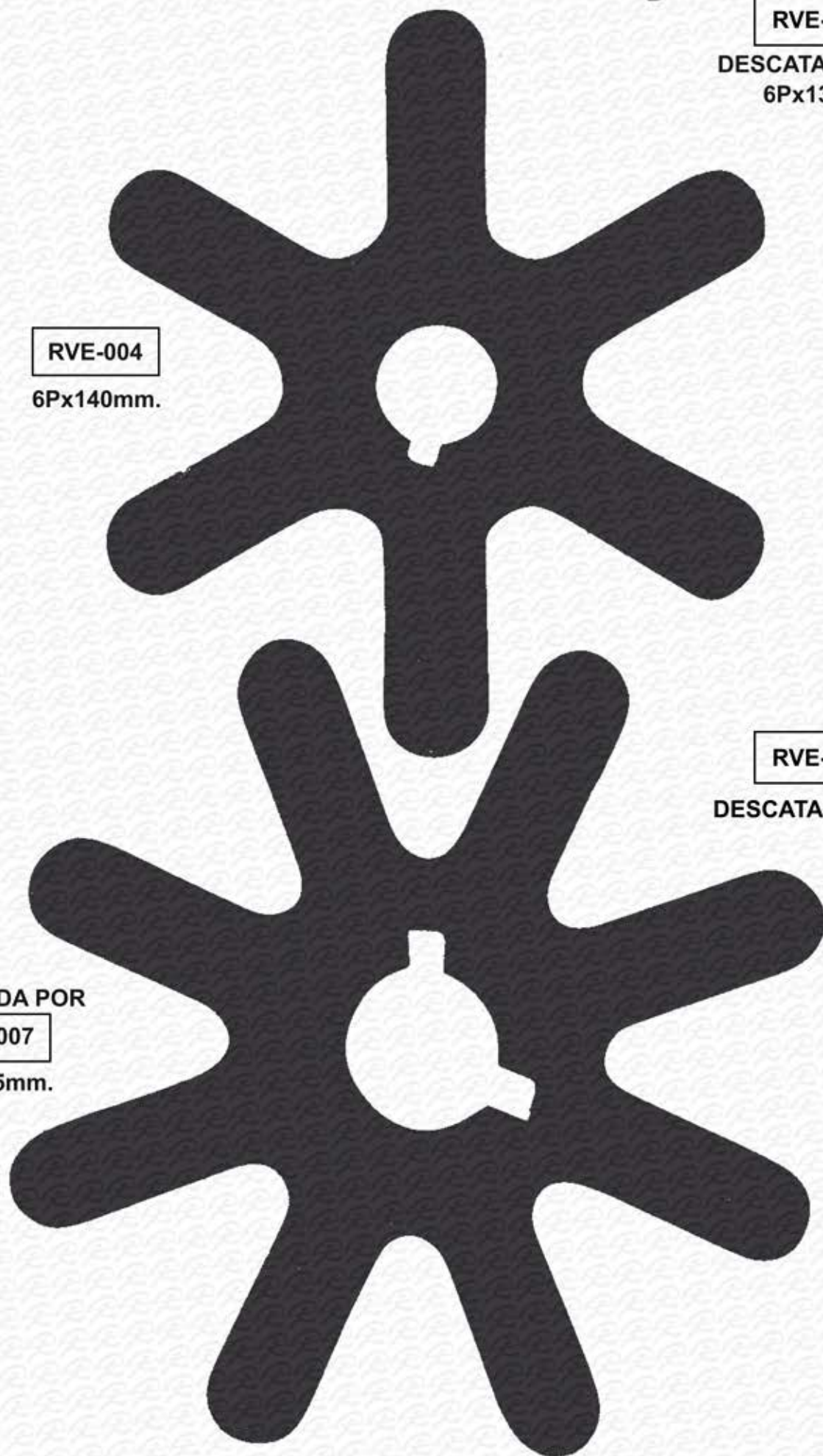



ESTUPIÑA

RVE-008

10Px185mm.

Esta RVE-008 va montada
como compañera la RVE-009.
Si existe duda consultar.

MAQUINA MODELO
5000/10



MEJORA Máquinas equipadas con platos de aluminio de $\varnothing 90$ mm.
y lleven dedos RVE-001, podrán ser sustituidos por esta estrella RVE-008
(Hay que torneear los discos)

RVE-009

10Px205mm.

ESTUPIÑA

MÁQUINA MODELO
5000/10



MEJORA Máquinas equipadas con platos de Aluminio de $\varnothing 90\text{mm}$.
y llevan dedos largos RVE-002 podrán ser sustituidos por esta estrella RVE-009
(Hay que tornear los discos)



ESTUPIÑA

FABRICACIÓN
SOBRE PEDIDO

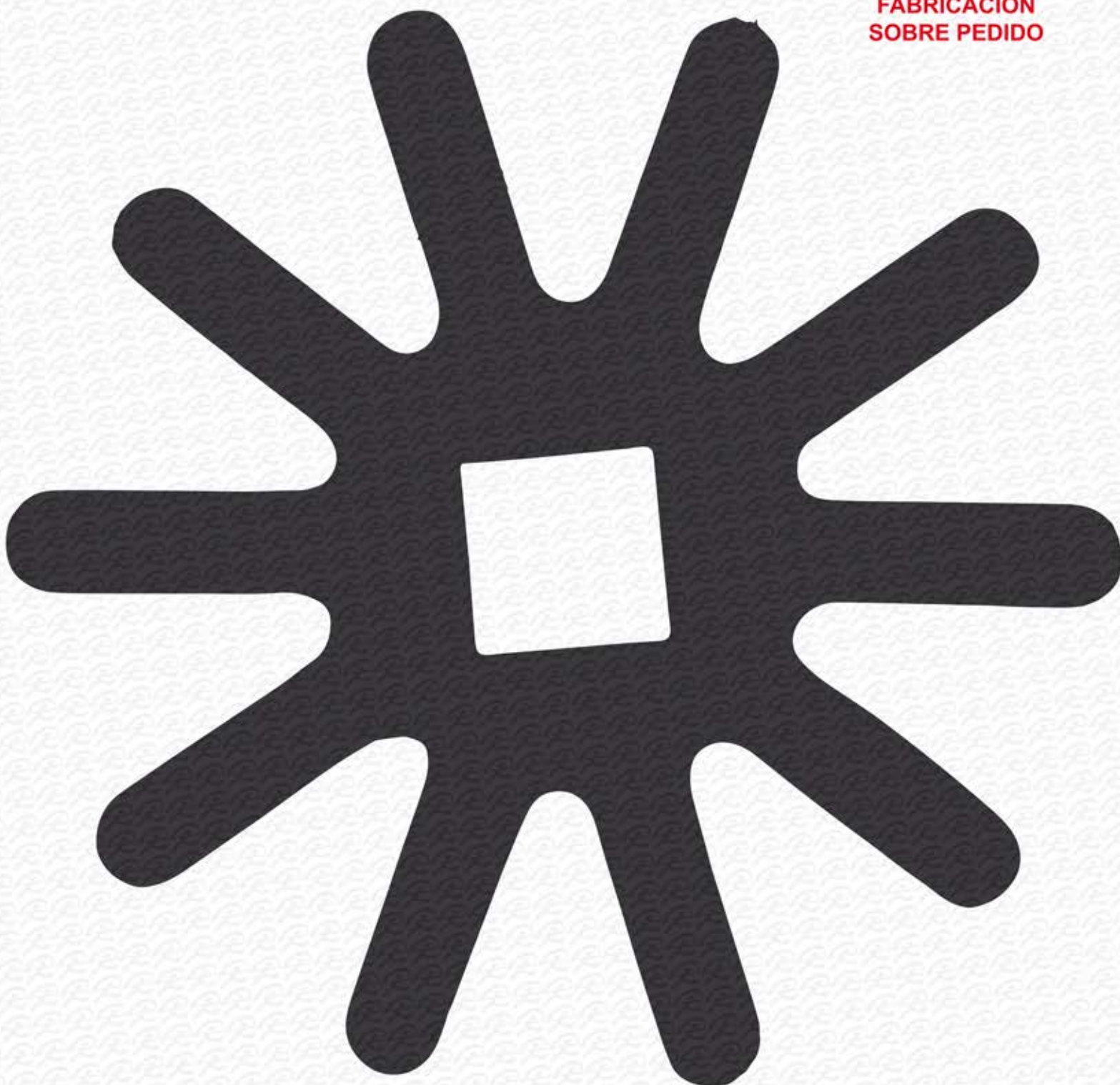

RVE-062

COSECHADORAS
10Px205mm.



ESTUPIÑA

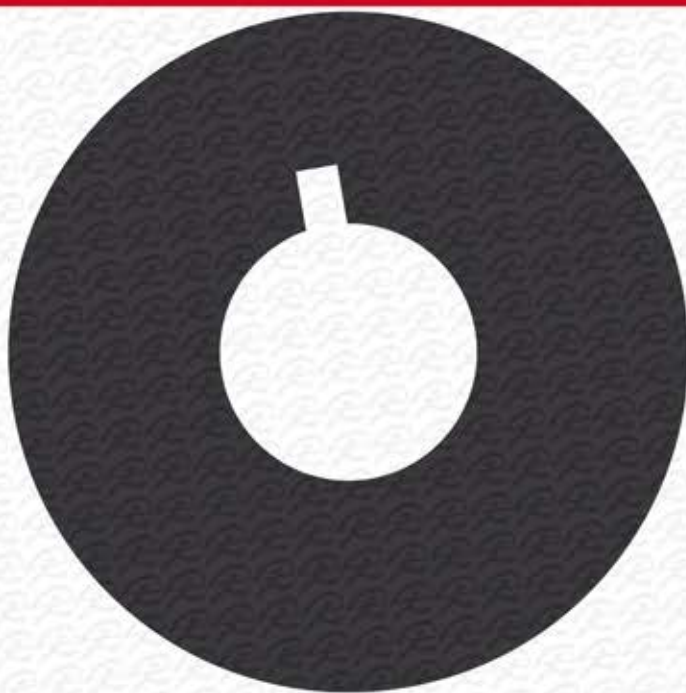

16139238

SEPARADOR DE GOMA
Ø90mm. CON CHAVETERO



RVE-012

8Px190mm.

FABRICACIÓN SOBRE PEDIDO



ESTUPIÑA

RVE-044

9Px200mm.



FABRICACIÓN SOBRE PEDIDO

ESTUPIÑA

RVE-010

12Px225mm.



FABRICACIÓN SOBRE PEDIDO

MEJORA Máquinas equipadas con discos de aluminio de $\varnothing 128\text{mm}$. y lleven dedos cortos RVE-001 podrán ser sustituidos por esta estrella RVE-010.
(Hay que torneear los discos)



RVE-011

12Px245mm.

ESTUPIÑA



FABRICACIÓN SOBRE PEDIDO

MEJORA Máquinas equipadas con discos de aluminio de $\varnothing 128\text{mm}$. y llevan dedos largos RVE-002 podrán ser sustituidos por esta estrella RVE-011.
(Hay que torneear los discos)



ESTUPIÑA

RVE-019

SEPARADOR DE GOMA

Ø90mm.-35x35mm.

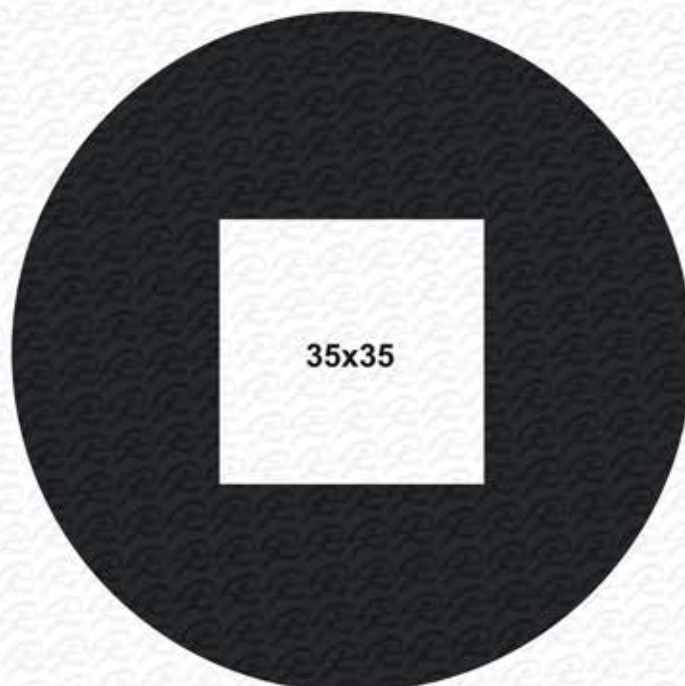

35x35



RVE-061

MODELO 200-900
4Px190mm.



ESTUPIÑA

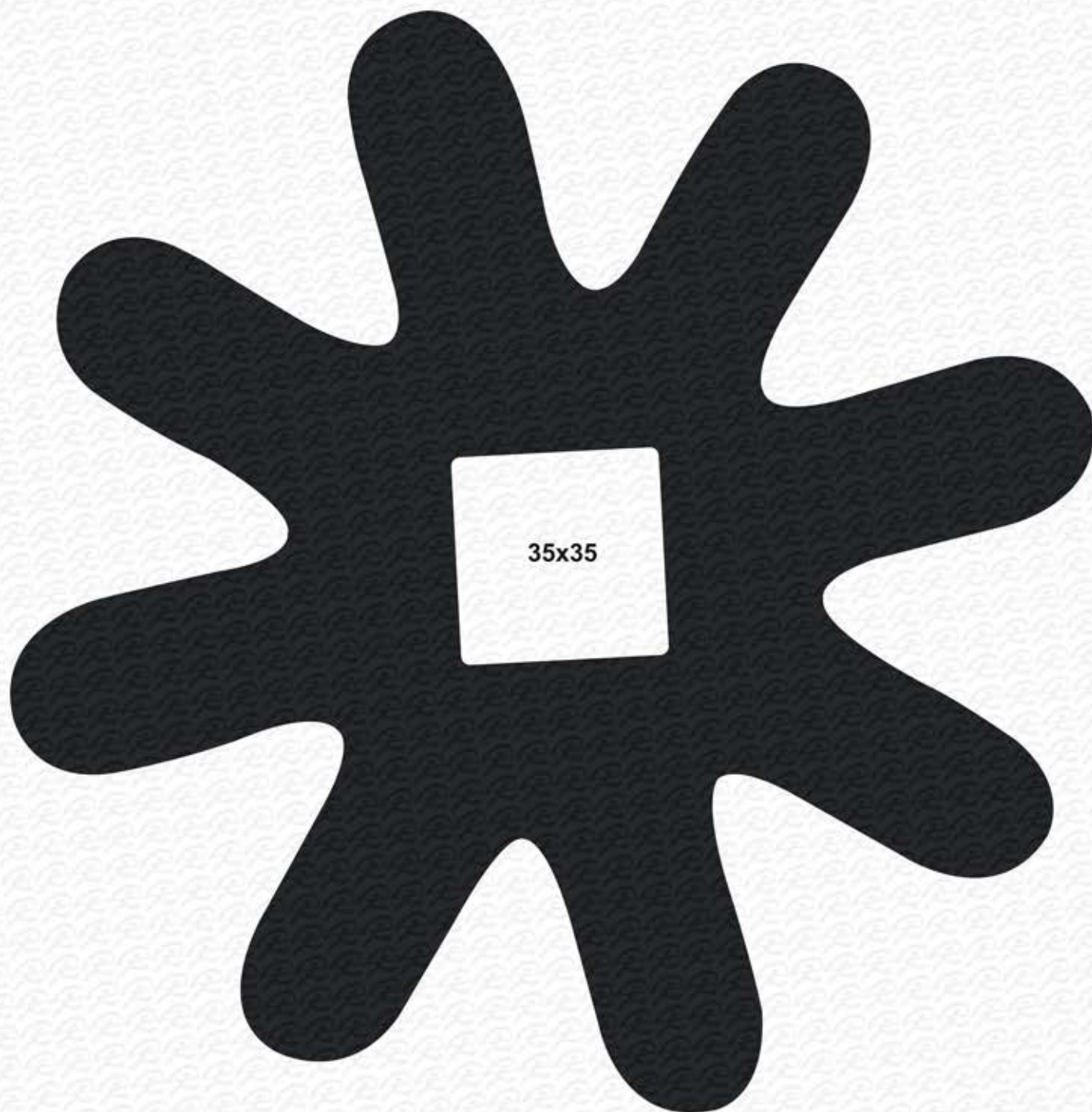

RVE-060

MODELO 200-900
COSECHADORAS E INSTALACIONES
8PXx190mm.



RVE-001

DEDO CORTO
L: 62mm.

MEJORA: Estos dedos pueden ser sustituidos opcionalmente por la estrella RVE-008 para las máquinas equipadas con plato de aluminio de $\varnothing 90\text{mm}$. Para máquinas con plato de aluminio de $\varnothing 128\text{mm}$. se pueden instalar la estrella RVE-010 torneando los platos de aluminio.



RVE-002

DEDO LARGO
L: 75mm.

MEJORA: Estos dedos pueden ser sustituidos opcionalmente por la estrella RVE-009 para las máquinas equipadas con platos de aluminio de $\varnothing 90\text{mm}$. Para máquinas con platos de aluminio de $\varnothing 128\text{mm}$. se pueden instalar la estrella RVE-011 torneando los platos de aluminio.

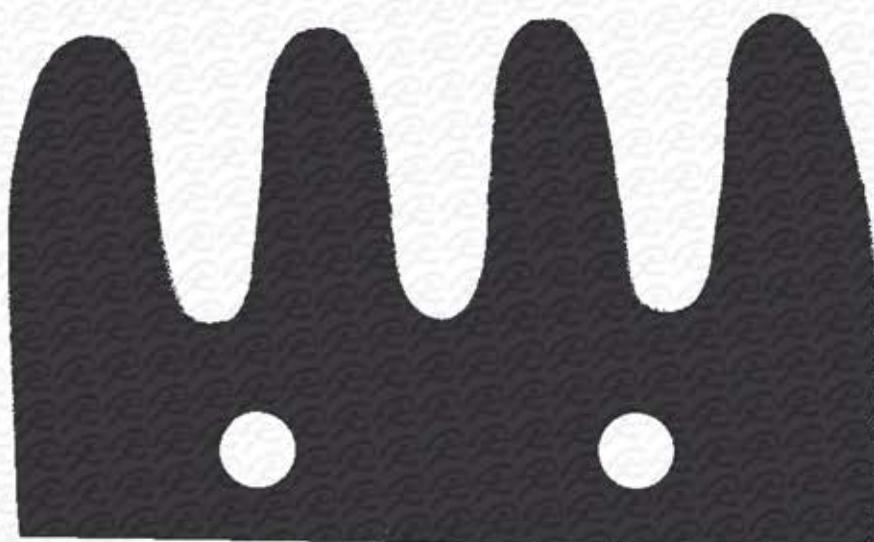

RVE-017

FABRICACIÓN SOBRE PEDIDO



BLANC • BORRAS • PUIG DELLIVOL • SOLANO • TOPAVI Y OTRAS COSECHADORAS

RVE-045 D

**DOBLE GRUESO
26mm.**

RVE-045 NORMAL

RVE-045 FB BLANDA

RVE-045

**Ø175mm.
MODELO PATENTADO**

COLOR BLANCO

RVE-045 C

**PISTACHO
Ø175mm.**

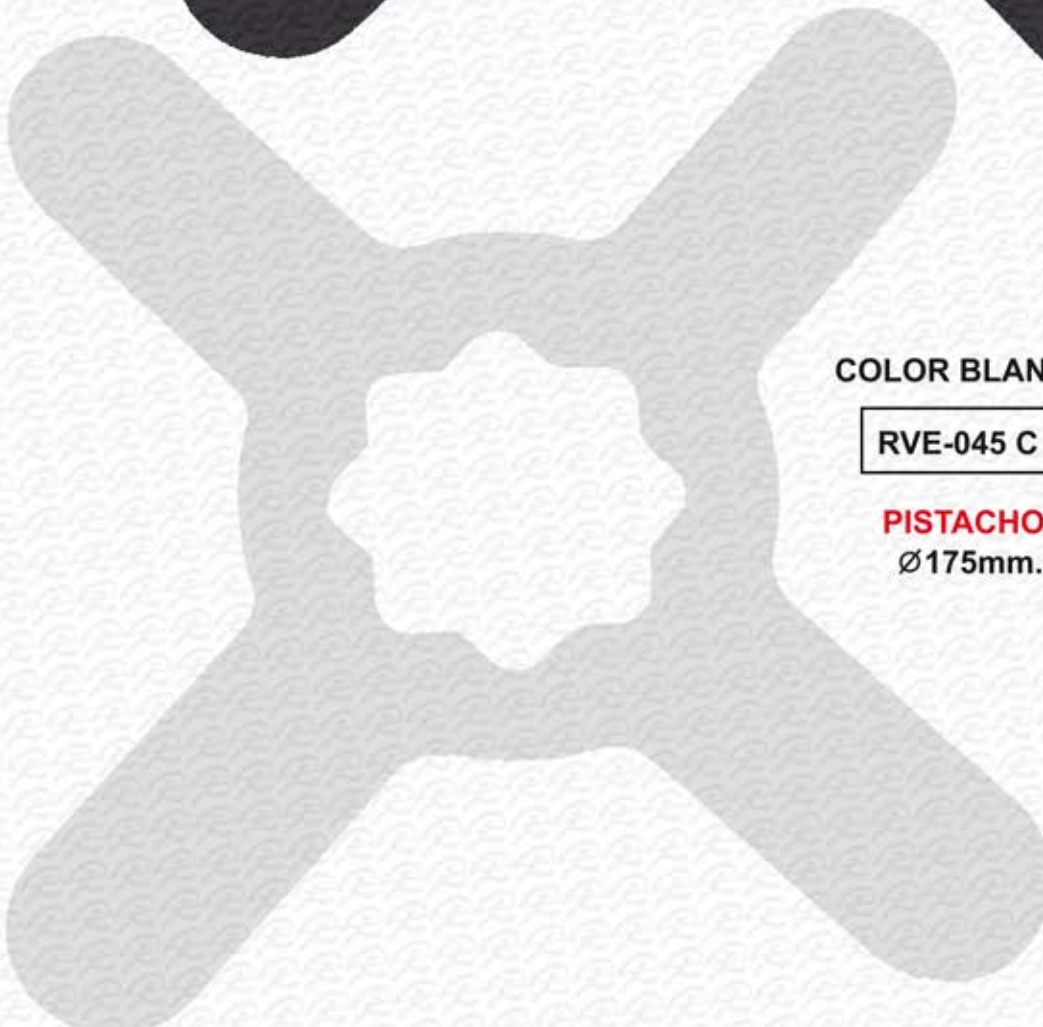
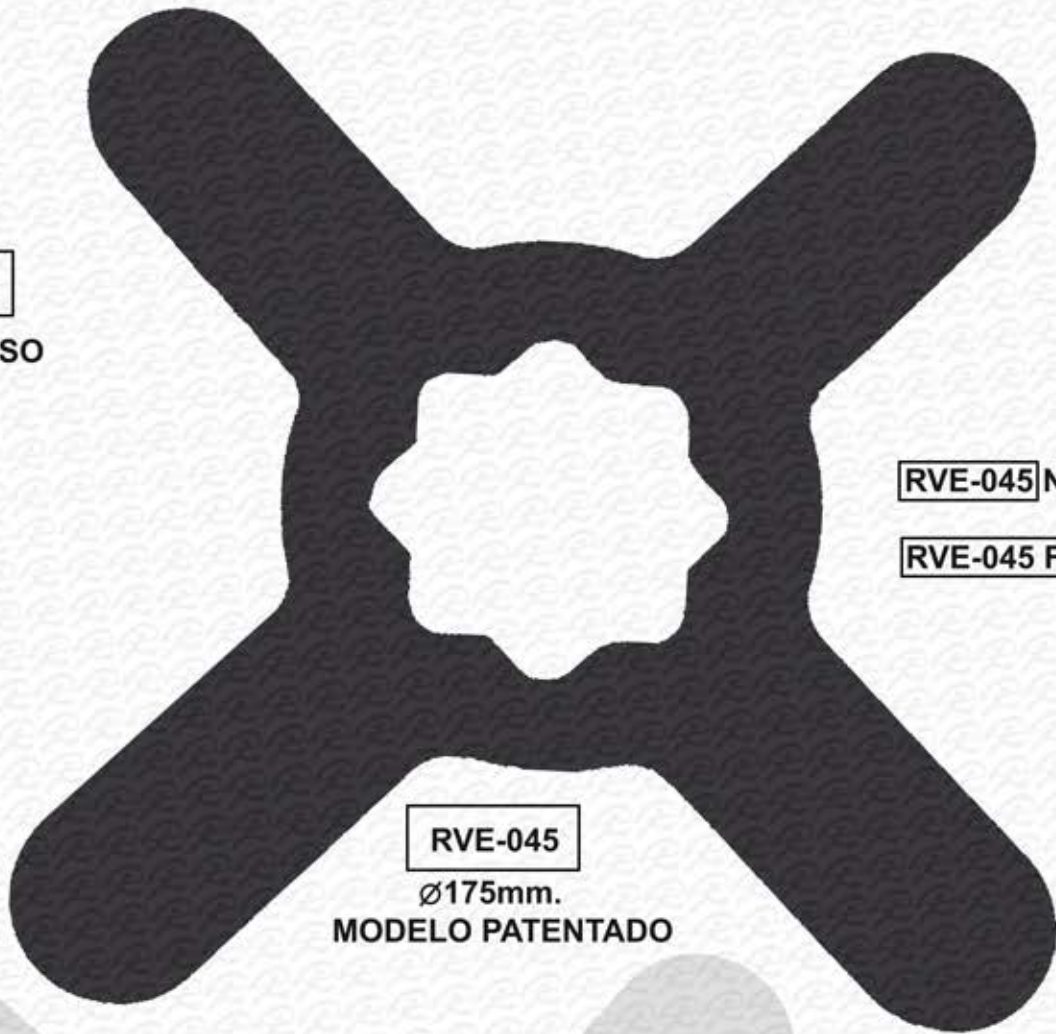

BLANC

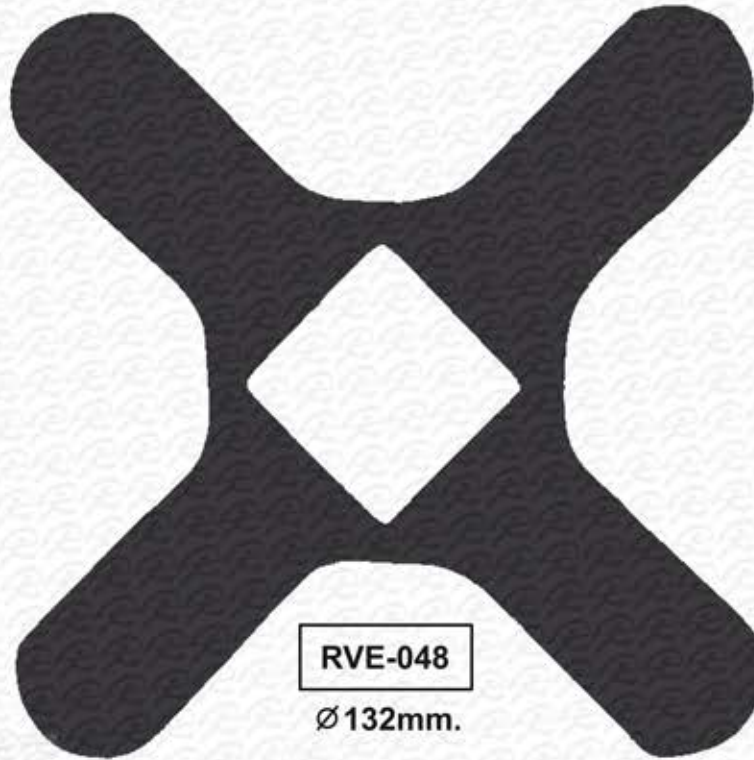

RVE-048

Ø 132mm.



CÓDIGO	ARTÍCULO
16137858	Espiral Alimentador

SEPARADOR
PARA ESTRELLA
RVE-045 - 046

RVE-049



CÓDIGO	ARTÍCULO
16137859	Eje con Tuerca



SOLO PARA SOLANO ANTIGUA

RVE-046

CORTA
Ø157mm.

SUSTITUIDA POR
LA RVE-045 CON
INTERIOR OCTAGONAL

RVE-046

Ø157mm.

SOLANO

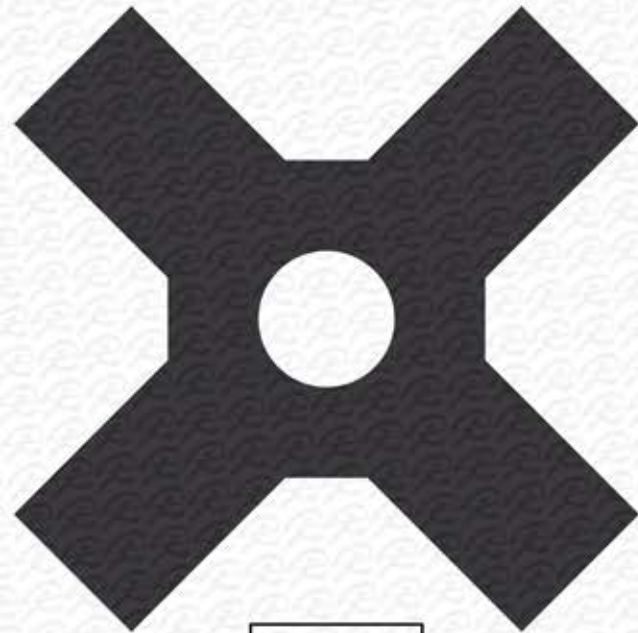

RVE-041

4Px95mm.

PUIGDELLIVOL BORRAS

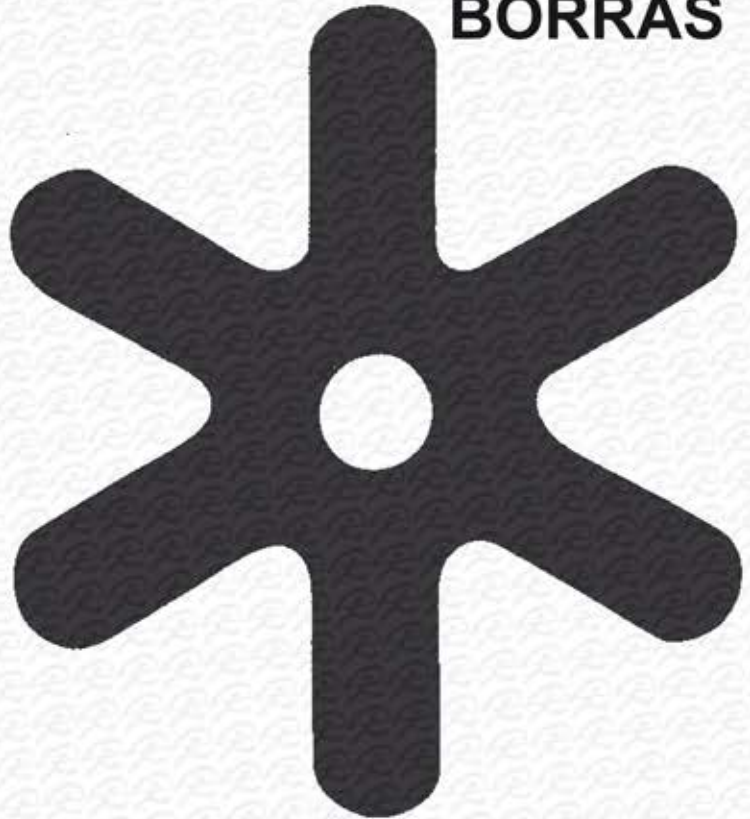

RVE-031

Ø 105mm.

BORRAS

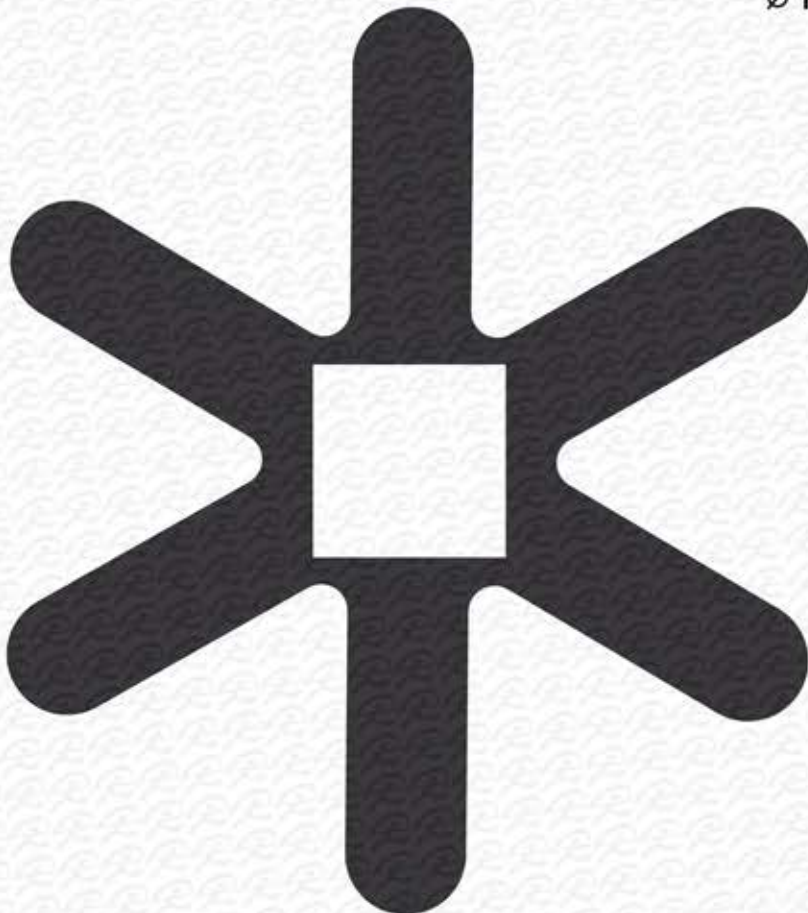

RVE-043

6Px120mm.



PUIGDELLIVOL BORRAS

RVE-058

12Px205mm.



V y Dedos con Talón sustituidos
por Estrellas RVE-058 o RVE-55
con Discos de Aluminio torneados



PUIGDELLIVOL BORRAS

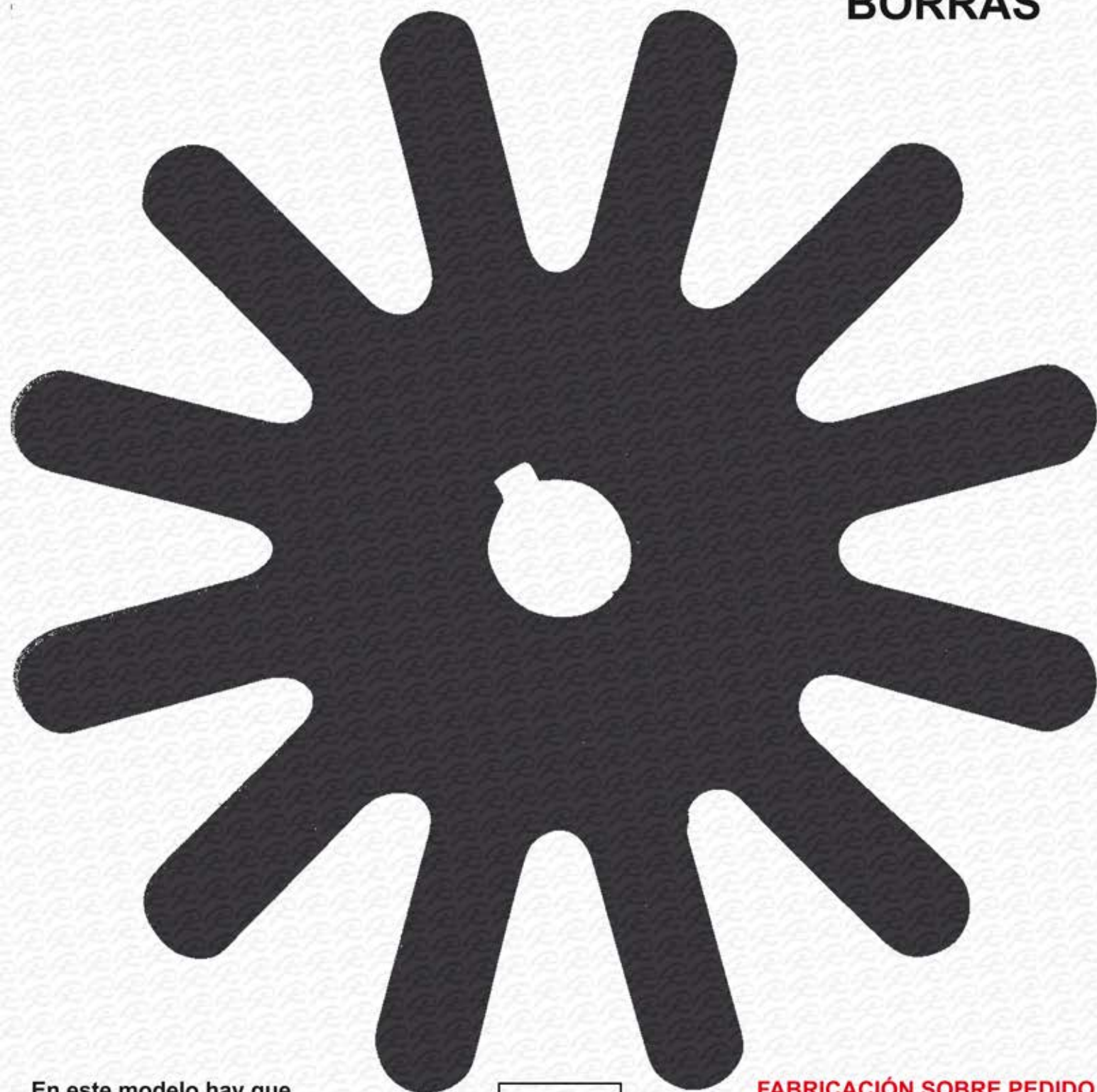

En este modelo hay que troquelar los discos de aluminio.

RVE-055

12Px205mm.

FABRICACIÓN SOBRE PEDIDO

Sustituida por la RVE-058

SE MONTA SIN NECESIDAD DE TORNEAR EL DISCO DE ALUMINIO



PUEYO

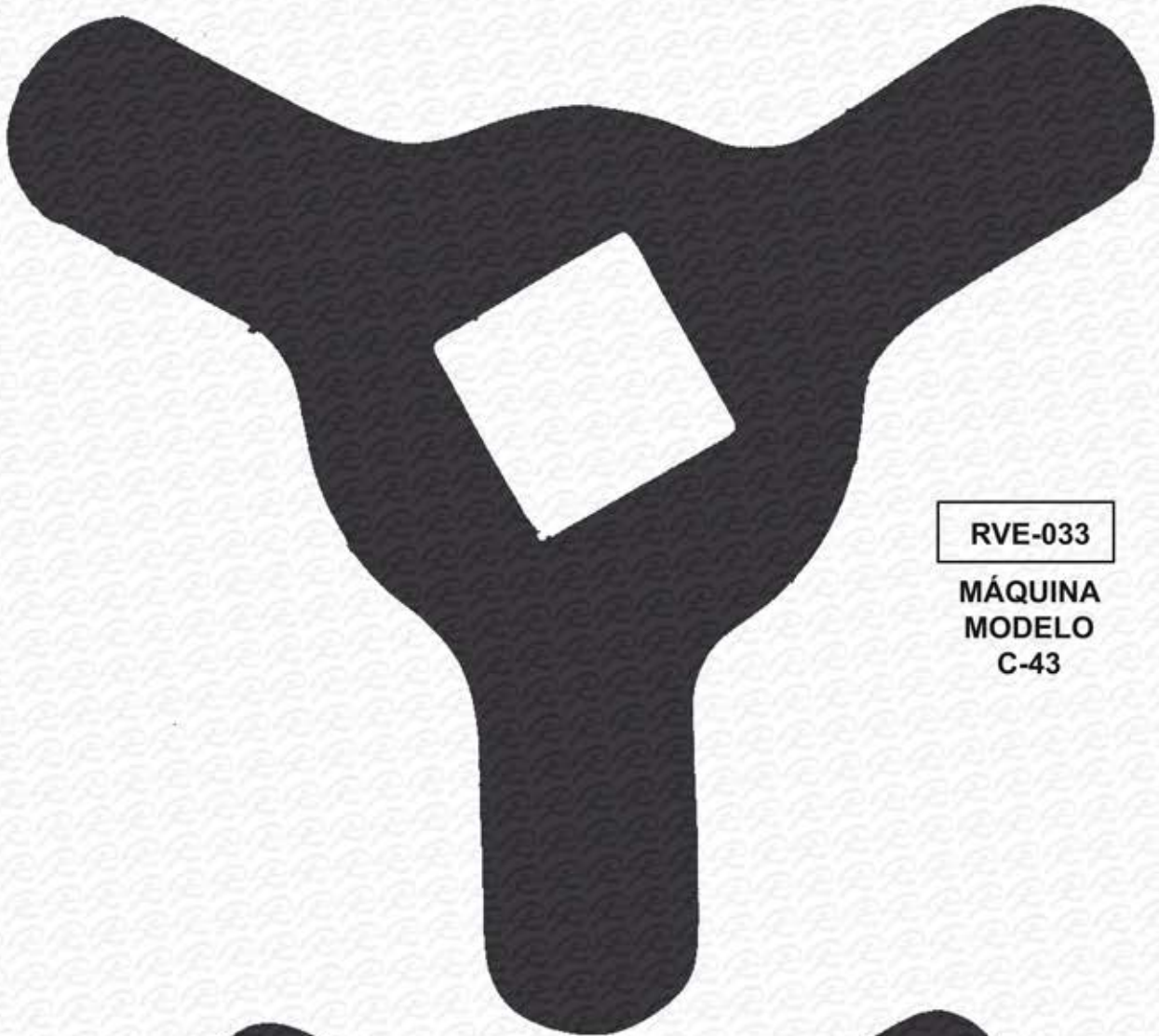

RVE-033

**MÁQUINA
MODELO
C-43**

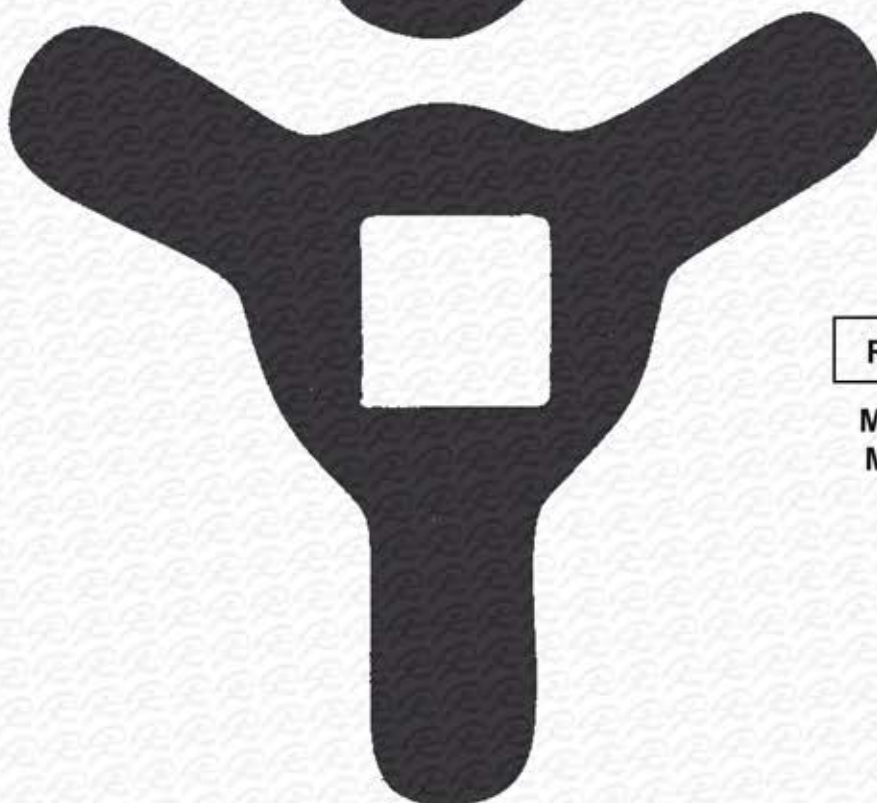

RVE-038

**MÁQUINA
MODELO
C-15**



PUEYO



MÁQUINA MODELO
C-54

RVE-056

4Px95mm.

PUEYO
C-54



16040225

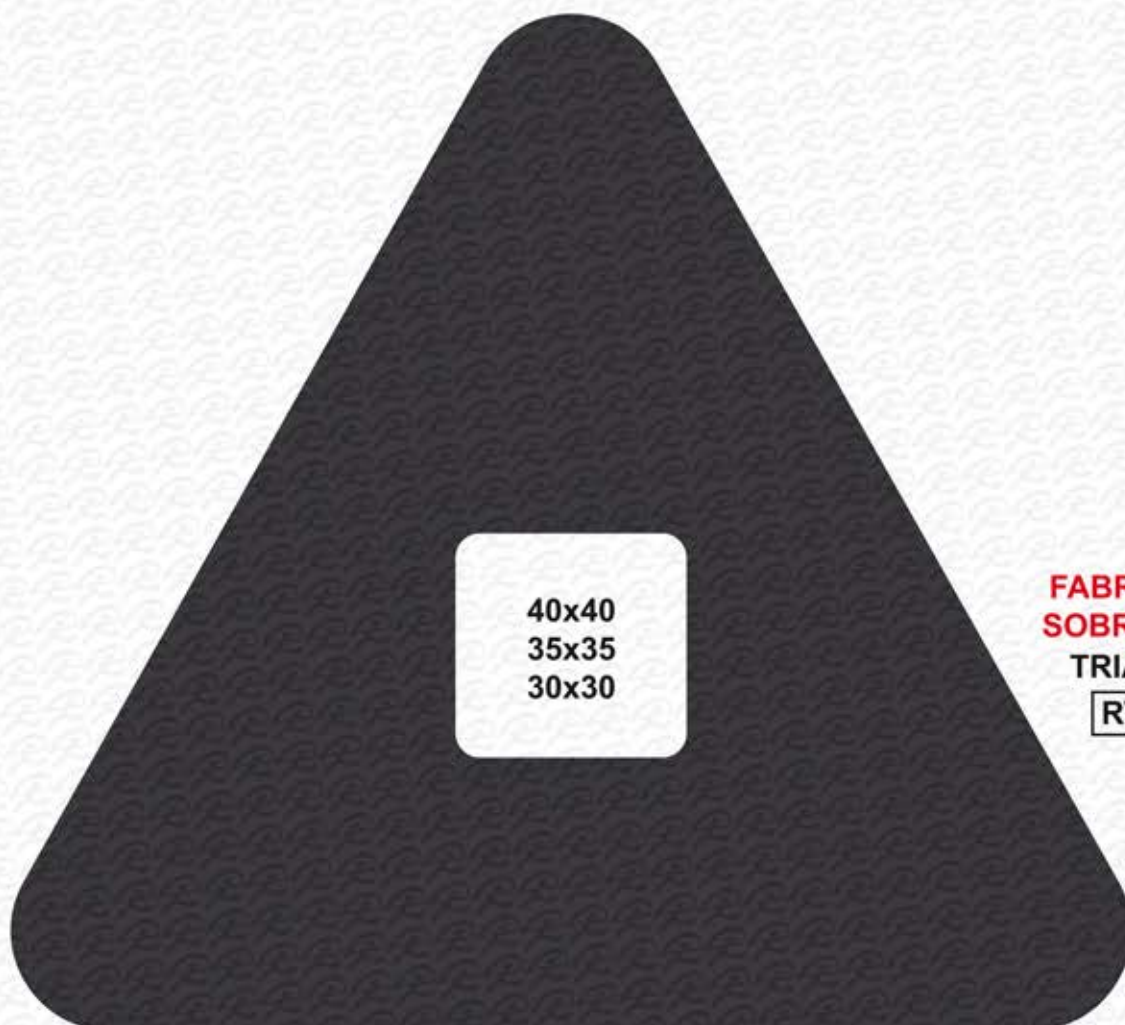

40x40
35x35
30x30

FABRICACIÓN
SOBRE PEDIDO
TRIÁNGULO

RVE-TRI



SOLANO

PELADORA AR-800 DE 8 RODILLOS

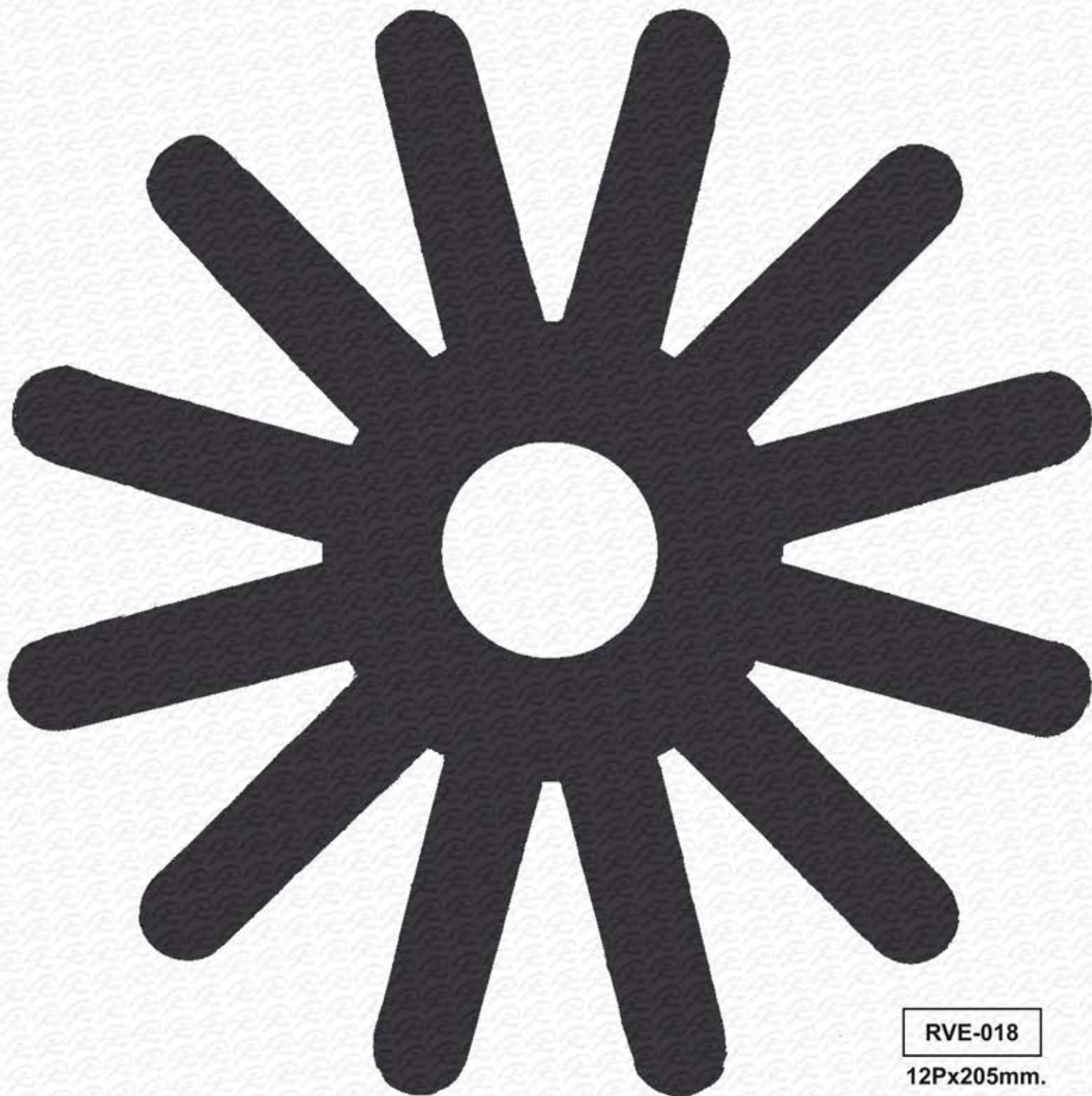

RVE-018

12Px205mm.

PARA SUSTITUIR
LOS DEDOS DOBLES-V
RVE-042



FONDÓN

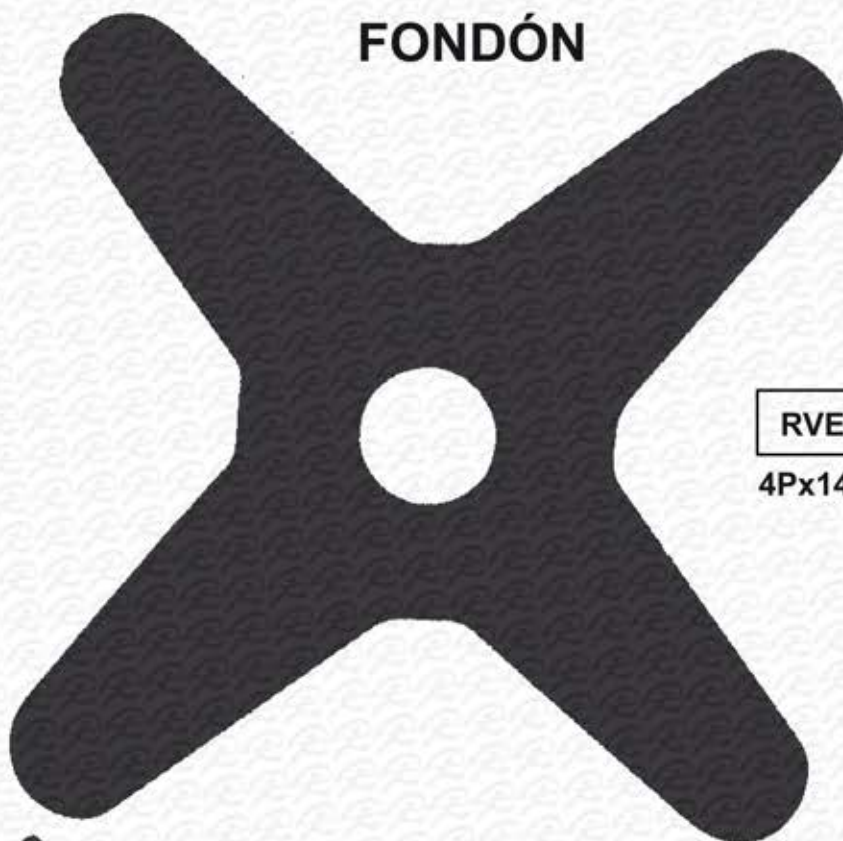

RVE-051

4Px140mm.

GRANADA



RVE-050

4Px175mm.

FABRICACIÓN SOBRE PEDIDO



RIPOLLES



FABRICACIÓN SOBRE PEDIDO

RVE-057

230x85mm.



RIPOLLES

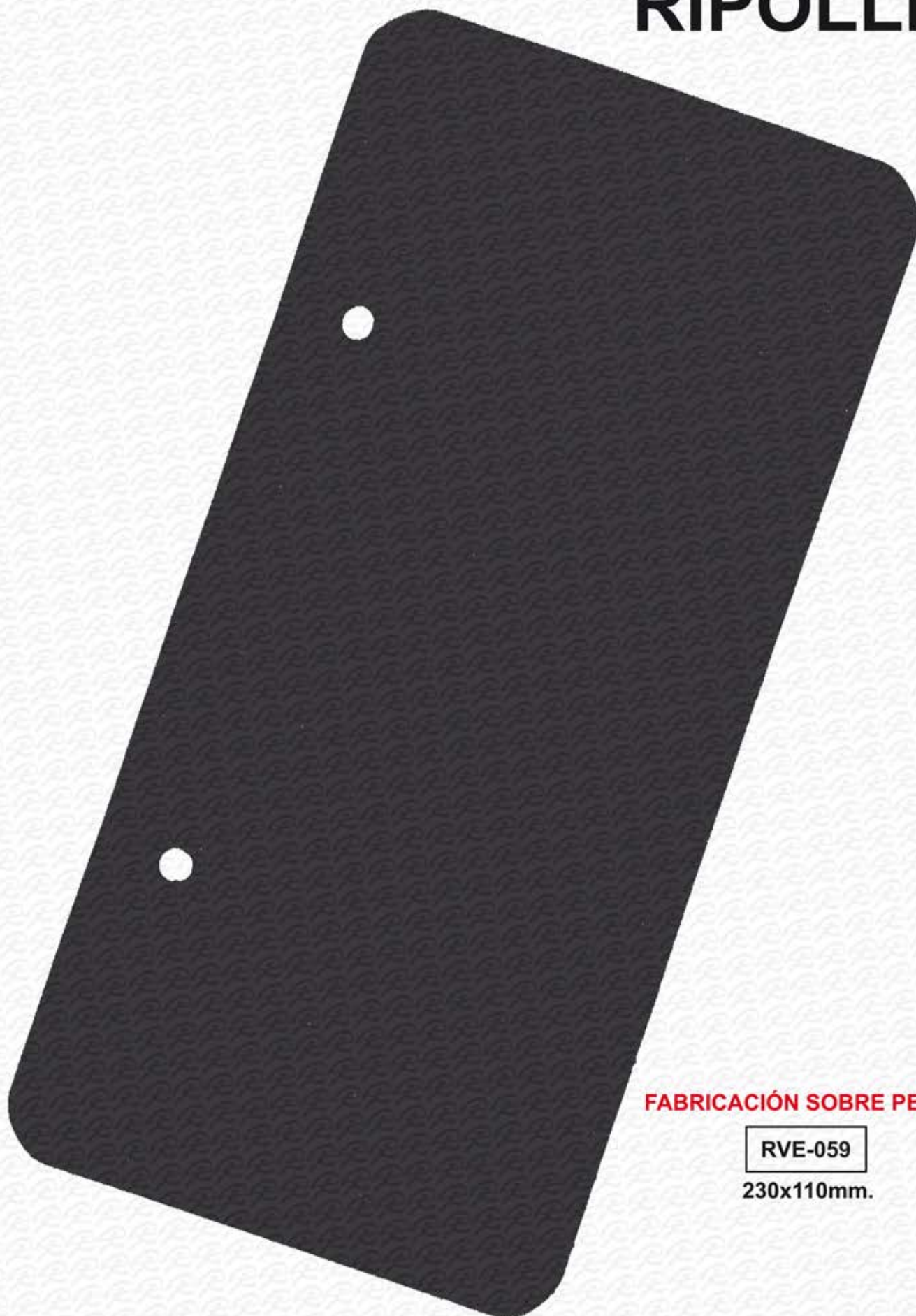

FABRICACIÓN SOBRE PEDIDO

RVE-059

230x110mm.



ESTRELLAS RECOLECTORAS DE HORTALIZAS

FABRICACIÓN SOBRE PEDIDO



Ø160mm.



RXX-007

JUNTA OVALADA
ABONADORAS
290x220mm.



CEPILLOS
DE
PELAR FLORES

PEL-004



**PLANCHA GOMA EN ROLLOS
 CON TEJIDO INTERIOR**

*Se sirve por metros
 Corte a medida

COD-5895

Fieltro grueso 10mm.
 Color gris
 Ancho del Rollo 1,6m.



COD-5920

Fieltro grueso 15mm.
 Color gris
 Ancho del Rollo 1,6m.
 Se puede servir por metros

MEDIDAS MÁS USUALES

CÓDIGO	ANCHO mm.	GRUESO	LONAS
RCF 108	400	6	2
RCF 107	400	7	3
RCF 109	500	9,5-10	3
RCF 106	600	7	3
RCF 101	600	10,5	4
RCF 103	600	9,5-10	3
RCF 104	700	9,5-10	3
RCF 105	800	9,5-10	3
RCF 102	800	10,5	4

*Disponemos de otras medidas

RCF 110

Plancha de goma
 Tipo CAMELO
 Color beig
 Grueso 10mm.
 Ancho del Rollo 1,5m.
 Se puede servir por metros



14110014

Cuerda Elástica
 Forrada Ø8mm.
 Rollo de 10m.

14110016

Cuerda Elástica
 Forrada Ø10mm.
 Rollo de 10m.

**BANDAS DE CONTENCIÓN
 TIPO S-80
 BASE: 53mm. ALTO: 80mm.**

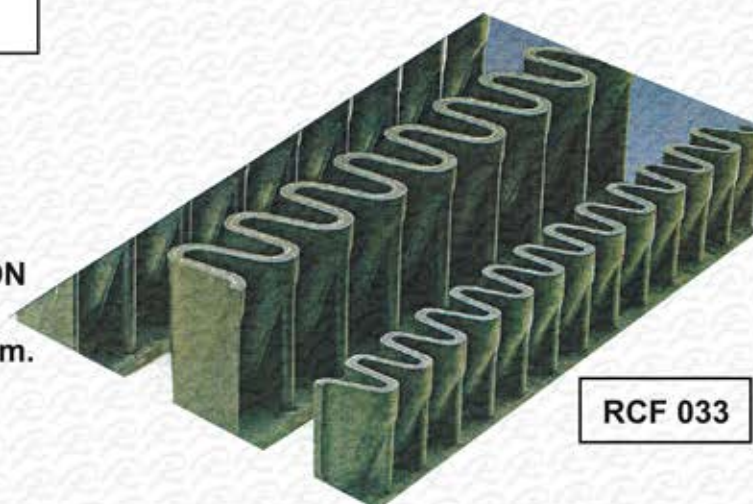

RCF 033



175mm.

CÓDIGO	DESCRIPCIÓN
RVE 045	Normal en Negra
RVE 045 FB	Blanda Negra
RVE 045 D	Doble grueso Negra
RVE 045 C	Color Blanca "Pistacho"

TOPAVI

15,30 Kg.



705mm.

PARRILLA Peladora TOPAVI RVE 070



RVE 049

SEPARADOR PARA ESTRELLA RVE 045



Espiral alimentación M-6 TOPAVI RVE 072



Eje Peladora TOPAVI Rosca Izqda. RVE 071

Tuerca Eje Peladora TOPAVI Izqda. RVE 074



Engranaje Z - 18 Dientes Eje Peladora TOPAVI RVE 073

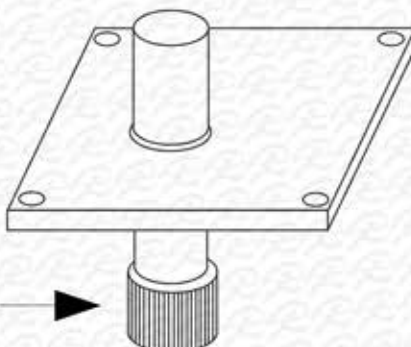



FALDILLAS

SOLANO

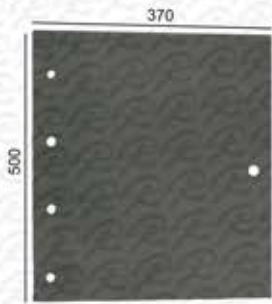

RCF 012

VIBRADOR TRASERO
FALDILLA



RCF 013

VIBRADOR TRASERO
CUBRE CILINDRO

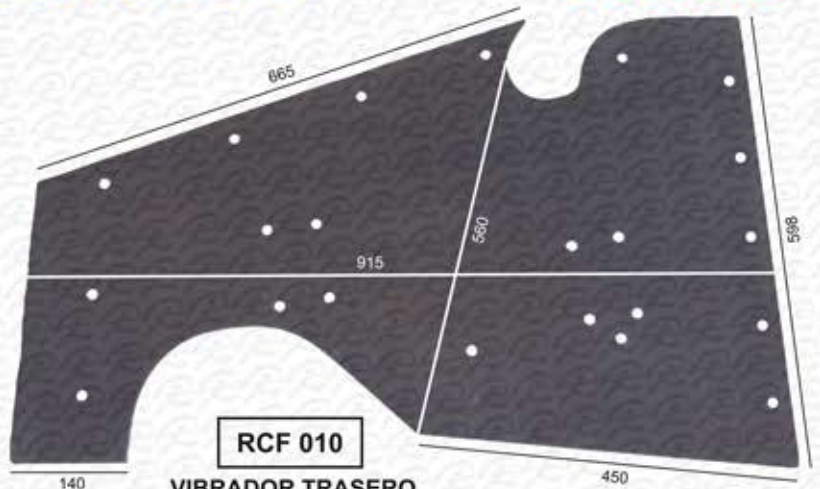

RCF 010

VIBRADOR TRASERO
FALDETA



RCF 015

VIBRADOR DELANTERO

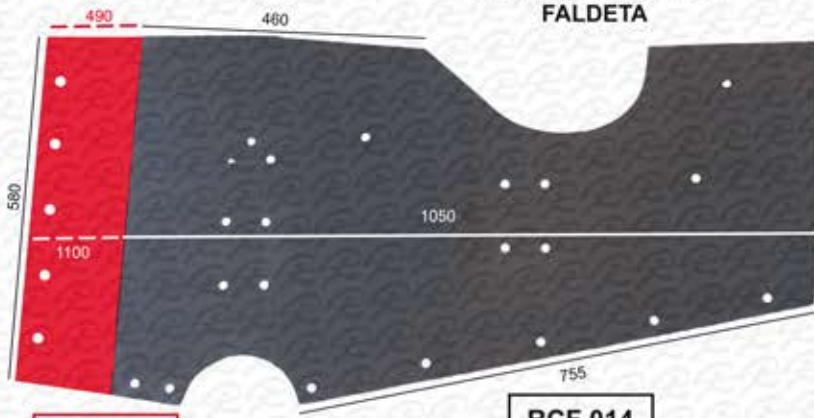

RCF 014N

VIBRADOR DELANTERO
CUBRE FALDÓN CIERRE TRONCO

RCF 014



RCF 011

VIBRADOR TRASERO
SUPLEMENTO CIERRE TRONCO



RCF 017

HERRADURA
SINFÍN

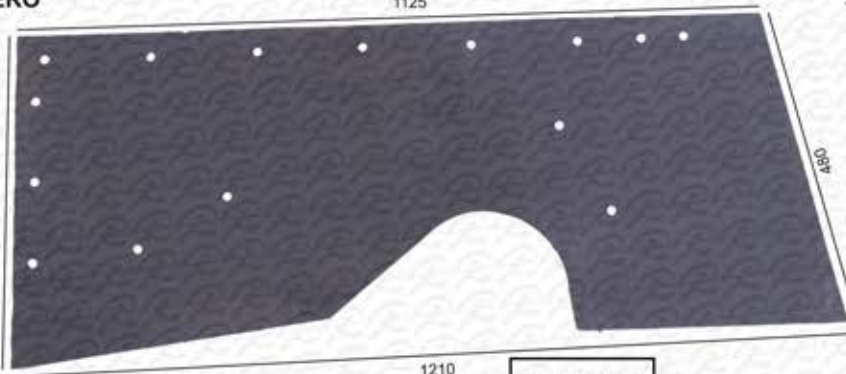

RCF 016

VIBRADOR DELANTERO
ANTIGUA 2003

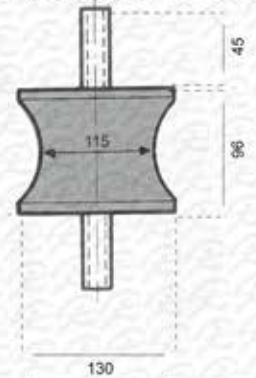

RVS 015

SOPORTE ANTIVIBRACIÓN

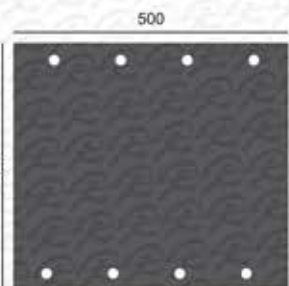

RCF 021

TIJERA DELANTERO

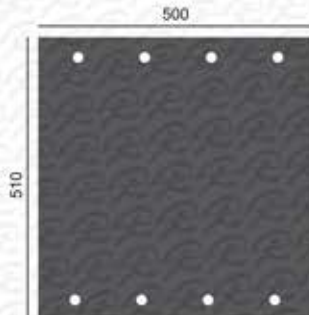

RCF 022

PROTECCIÓN TACO
REDONDO DELANTERO

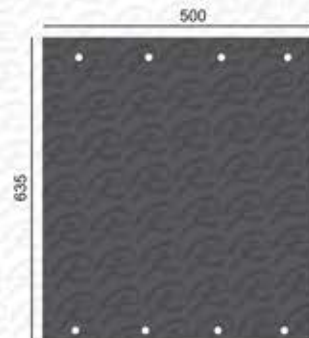

RCF 023

TIJERA CUBRE CILINDRO
DELANTERO



RCV 018

Taco Apoyo
Abanico en T
180x100



RCV 019

Taco Apoyo
Abanico en T
250x100



FALDILLAS

TOPAVI

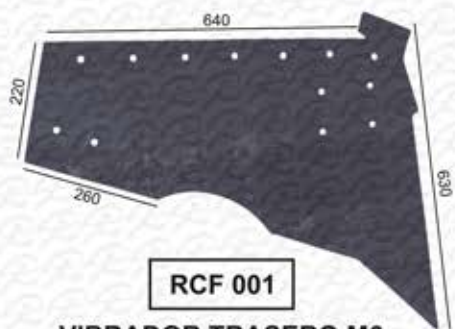

RCF 001

VIBRADOR TRASERO M6
FALDILLA CIERRE TRONCO

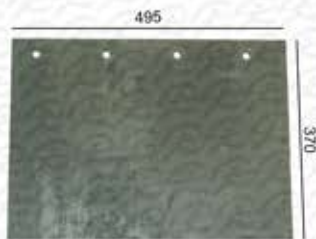

RCF 002

VIBRADOR
TRASERO M6
FALDILLA



RCF 018

FALDILLA FRONTAL
VIBRADOR-TENAZA

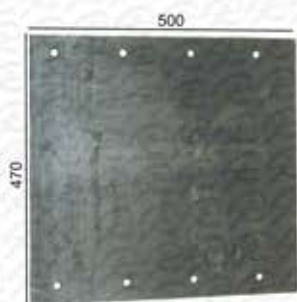

RCF 003

VIBRADOR TRASERO M6
CUBRE TACO



RCF 004

VIBRADOR TRASERO M6
CUBRE PINZA-TENAZA



RCF 009

VIBRADOR DELANTERO ANTIGUO
FALDÓN CIERRE TRONCO

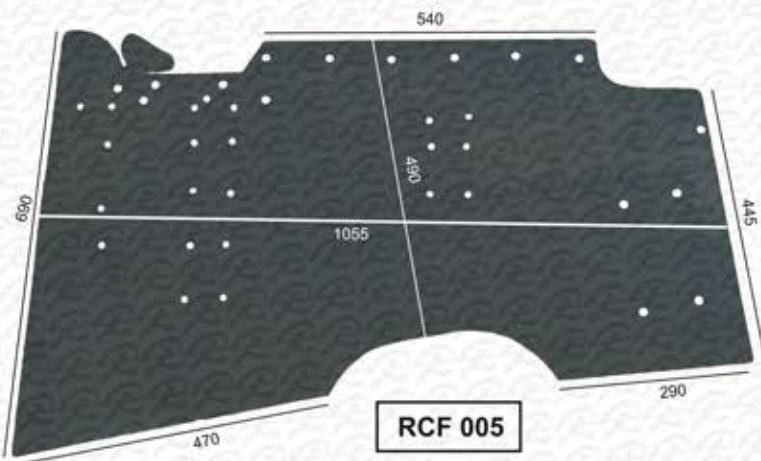

RCF 005

VIBRADOR DELANTERO
TRONCO

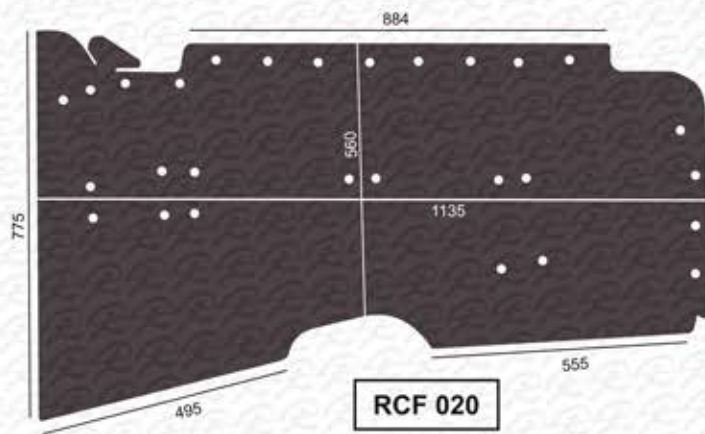

RCF 020

CIERRE TRONCO
DELANTERA

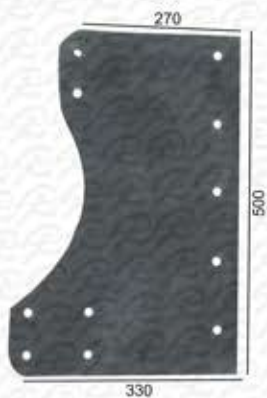

RCF 006

VIBRADOR DELANTERO

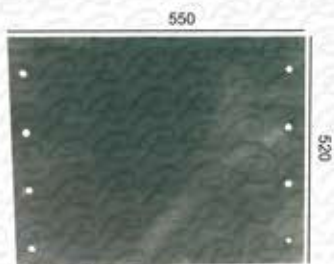

RCF 007

VIBRADOR DELANTERO
CUBRE CILINDRO

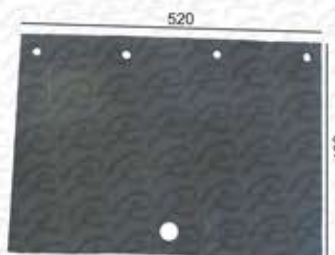

RCF 008

VIBRADOR DELANTERO
FALDILLA



RVS 109

SOPORTE ANTIVIBRACIÓN
Ø100 L-75 M-16



**PLANCHA GOMA EN ROLLOS
 CON TEJIDO INTERIOR**
 *Se sirve por metros
 Corte a medida



CILINDROS DE GOMA PARA VIBRADORES DE ARBOLES



**TOPAVI-SOLANO
 TAGRA**

RCV 001

L: 500x200x50
 Peso: 18,8Kg.



TAGRA

RCV 002

L: 500X170X35
 Peso: 11,6Kg.

RCV 004

L: 400X170X35
 Peso: 9,1Kg.



**TOPAVI-SOLANO
 T. OLLER**

RCV 003

L: 470X140X40
 Peso: 8Kg.



OTROS

RCV 007

L: 480X140X16
 Peso: 8,3Kg.

RCV 008

L: 375X140X40
 Peso: 5,8Kg.

RCV 009

L: 195X140X40
 Peso: 3Kg.

CILINDROS DIÁBOLO PARA VIBRADORES



SOLANO-PELEN

RCV 005

L: 270X130XR-16
 Peso: 5,1Kg.

**TOPAVI-SOLANO
 T. OLLER**

RCV 006

L: 270X140XR-16
 Peso: 5,7Kg.

OTROS

RCV 010

L: 220X100XM12
 Peso: 2,5Kg.

RCV 011

L: 270X100XM12
 Peso: 2,7Kg.

RCV 012

L: 180X100XM12
 Peso: 2,2Kg.

RCV 033

L: 270X100XM14
 Peso: 2,6Kg.

SINEMBLOCK



TOPAVI

RVS 109

Ø100X75 TM16
 Peso: 1,2Kg.

SOLANO

RVS 015

Ø130X96 M16
 Peso: 2Kg.





PELLENC



RCV 013

Taco de Goma CB-15
400X200X120 M12
14,4Kg.



RCV 017

Taco de Goma Plano
340X150X60 M12
4,3Kg.

RCV 014

Taco de Goma CB-80
480x200x120 M12
16,3Kg.



RCV 026

Taco de Goma Inclinado en V
390x155x150
6,6Kg.



RCV 015

Taco de Goma Hueco CB-80
370X150X105 M12
6Kg.



RCV 016

Taco de Goma Frontal en V
390x155x60
4Kg.



RCV 027

Taco de Goma Bimbo
220x180x120 M16



RCV 030

Taco de Goma Buggy Hueco 2
590X220X150
16,3Kg.



RCV 034

Taco de Goma Refrigerado con agujeros
475x225x125mm.
13,5Kg

FALDILLA BUGGY



400

RCF 024



TORNADO



RCV 020

Taco de Goma Central Piramidal
410x180x60 M10
Peso: 5,9Kg.



RCV 021

Taco de Goma Piramidal
410x180x100 M10
Peso: 8,8Kg.

TORNADO-TOPAVI



RCV 022

Taco de Goma Frontal Piramidal
310x180x65 M10
Peso: 4,8Kg.

TOPAVI



RCV 024

Taco de Goma Frontal
360x180x70 M10
Peso: 6,9Kg.

TORNADO



RCV 023

Taco Lateral
250x70x60 M10
Peso: 1,3Kg.

TOPAVI



RCV 025

Taco de Goma Lateral
290x75x60 M10
Peso: 2Kg.

VIBROMAC



RCV 028

Taco Lateral
200x200x80 M10

SOLANO



RVC 029

Taco de Goma
600x200x170
Peso: 19,9Kg.

TOPAVI



RCV 031

Taco de Goma
Hueco
480x200x150



RCV 032

Taco de Goma
Hueco
530x200x150
Peso: 18,6Kg.



A GRANDES MALES...PEQUEÑOS REMEDIOS

MUCHOS PÁJAROS YA TEMEN AL NUEVO CAÑÓN DE CAUCHOS INDALO

EL SISTEMA MÁS EFICAZ
para ahuyentar todo tipo
de animales de sus cultivos.

MÁS PRÁCTICO
y fácil de llevar.
Más ligero: 7,26 Kg.
Más Pequeño



MÁS SEGURO
Contra el viento.
Más protección de la
cámara de gas

MÁS FIABILIDAD
de encendido.
Nuevo sistema
electrónico.



MÁS POTENTE
125 decibelios.

MENOS MANTENIMIENTO
Cámara de gas más
pequeña.

MÁS ECONÓMICO
MENOS CONSUMO
17.000 detonaciones
por cada 10 Kg.
de gas butano.

MENOR TAMAÑO
MAYOR POTENCIA
NUEVO MODELO

EFICAZ PORQUE NO SE ACOSTUMBRAN

El nuevo cañón espantapájaros produce detonaciones aún más potentes. Además, para evitar que los animales se acostumbren, puede incorporar un temporizador (intervalos de 1,5 a 30 minutos) para variar la frecuencia de los disparos, se evita que los animales consigan adaptarse al ritmo de detonación.

INCLUSO EN DÍAS DE MUCHO VIENTO

El nuevo modelo incorpora una protección de la cámara de gas que minimiza la posibilidad de fallos en días de fuerte viento.

ACCESORIOS

TRÍPODE
Ideal para cubrir zonas
amplias o para cultivos
de altura y árboles.

TEMPORIZADOR
Permite programar el cañón
para arranque y paro automá-
tico a la hora deseada con
autonomía de hasta 9 días.





☎ 950 616 138 **FAX** 950 616 007

✉ pedidos@cauchosindalo.es

www.cauchosindalo.es

